

Installation instructions for PZ4AL-01597-00, PZ4AL-01588-00 Under Run Protective Shield Fuel Tank

LEXUS LX 570



Toyota Land Cruiser 200



Model Year **LX 570 - 2007/2012**

Vehicle Code **URJ201L-GNTGKW**

Part Number

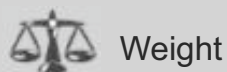

LC200 - 2007

UZJ200L-GNAEKW
VDJ200L-GNTEZW

LC200 - 2012

URJ202L-GNTEKW
VDJ200L-GNTEZW

Steel: PZ4AL-01597-00

Aluminium: PZ4AL-01588-00

Steel: 17,34 kg

Aluminium: 10,26 kg

50 min

A

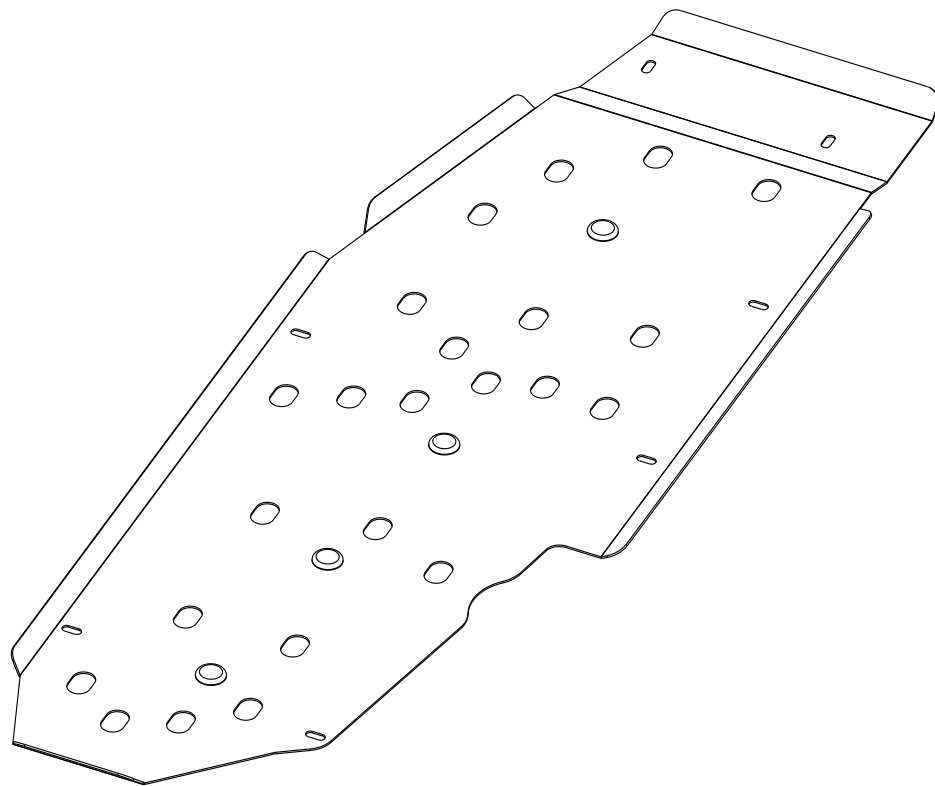

PZ4AL-01588-60

B1

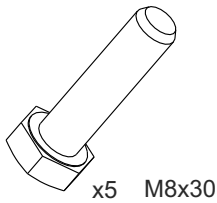

B2

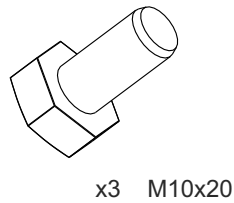

B3

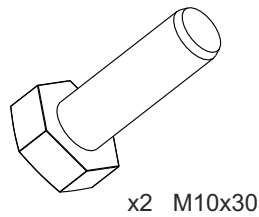

C1

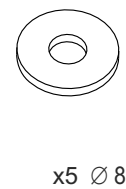

C2

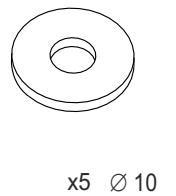

D

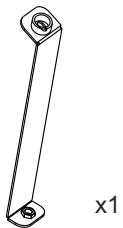

E

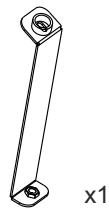

F

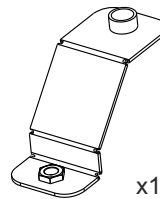

G

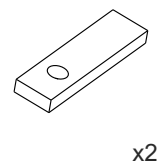

H

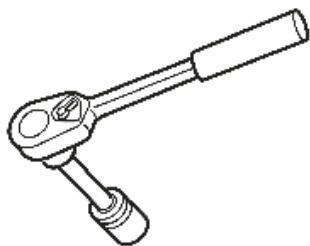
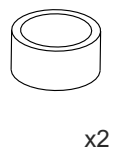

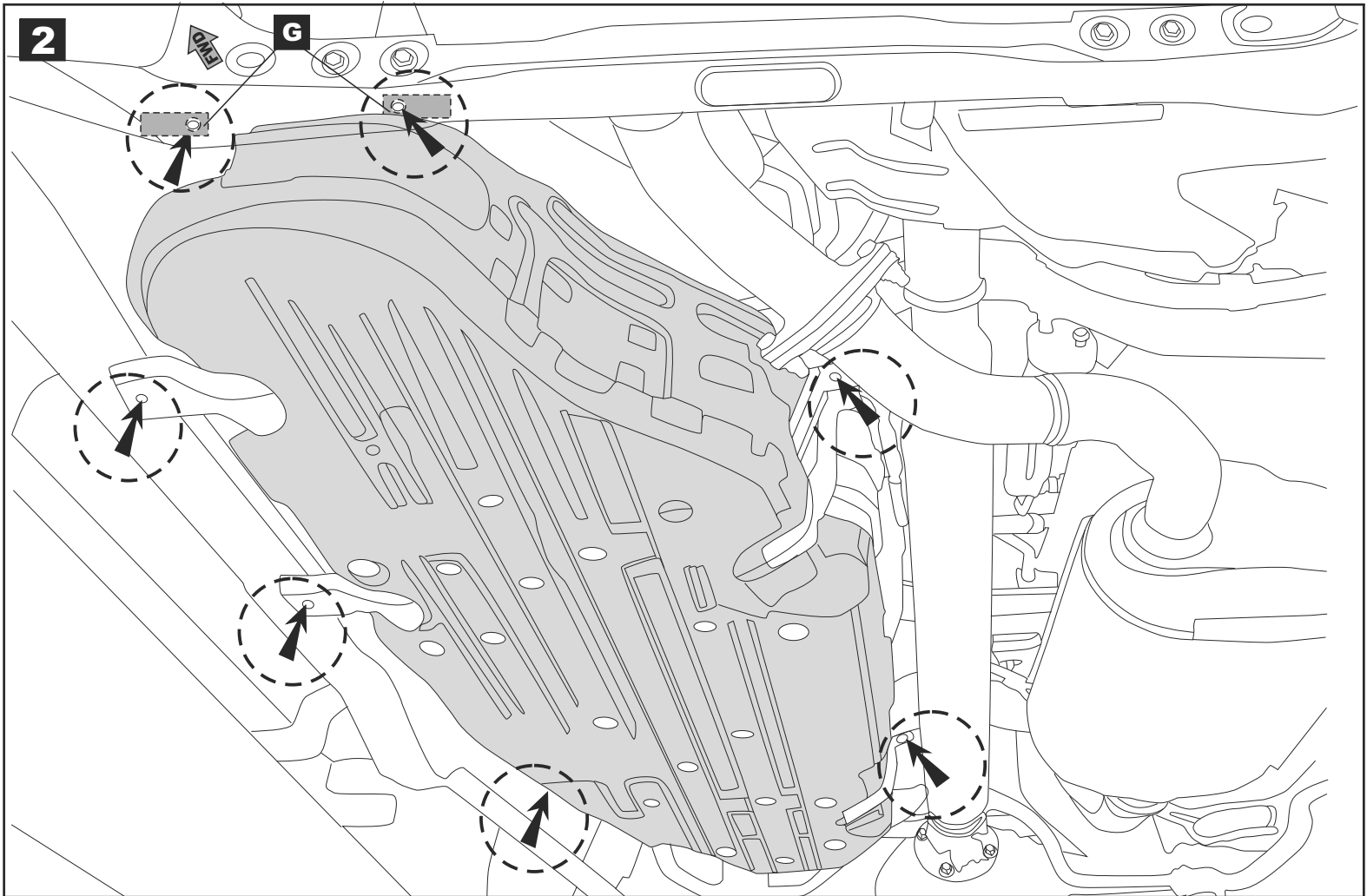
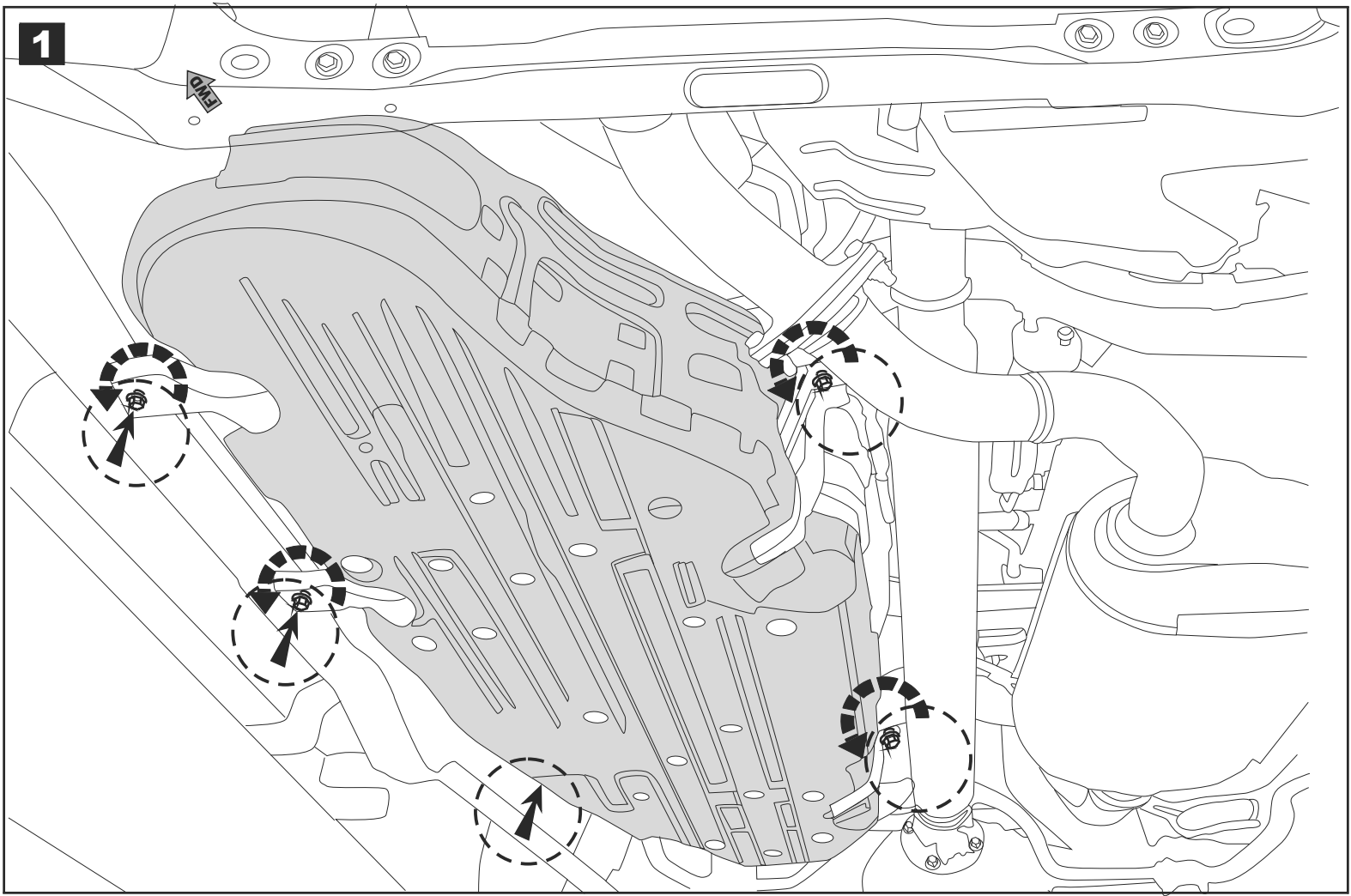

3

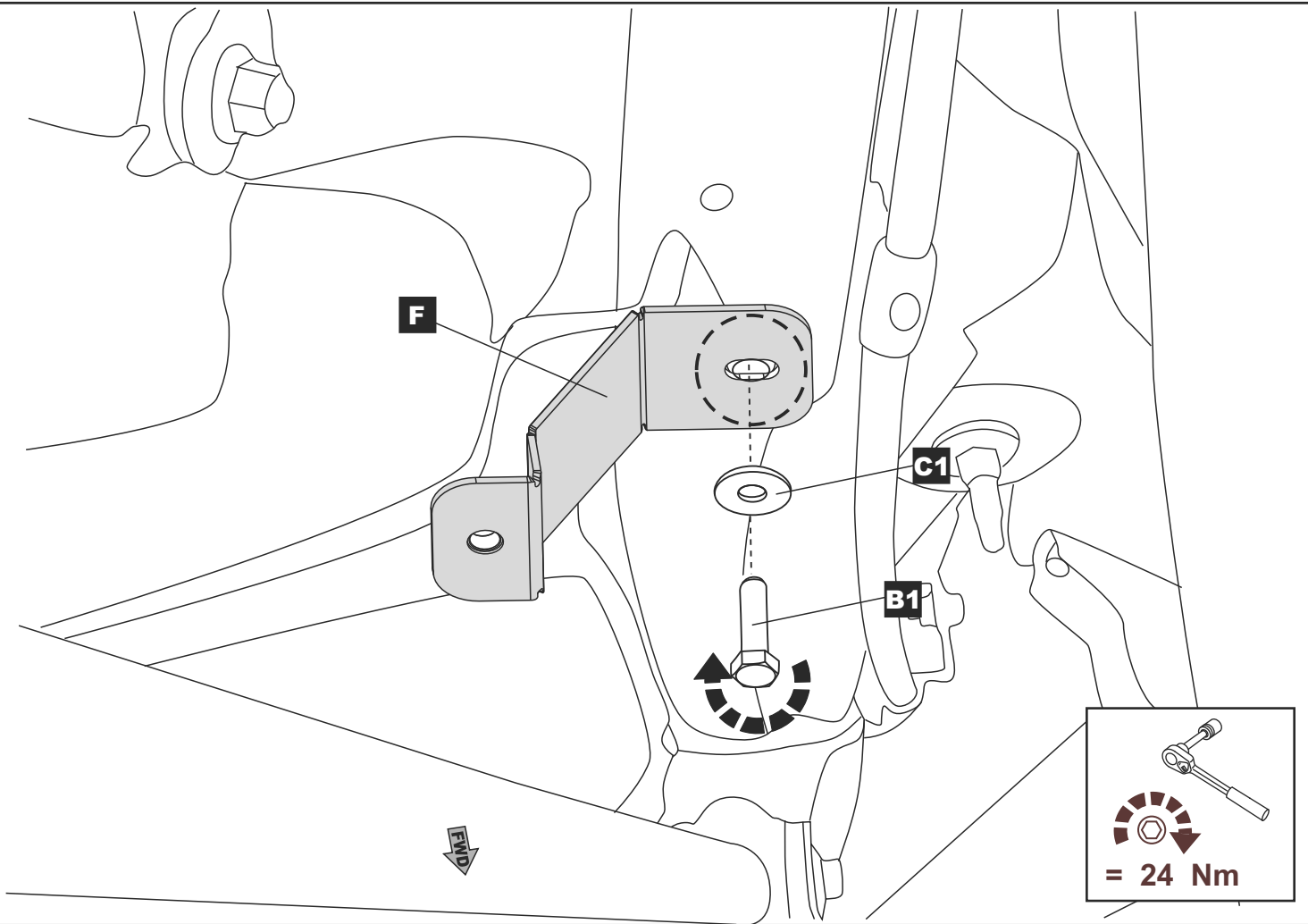

4

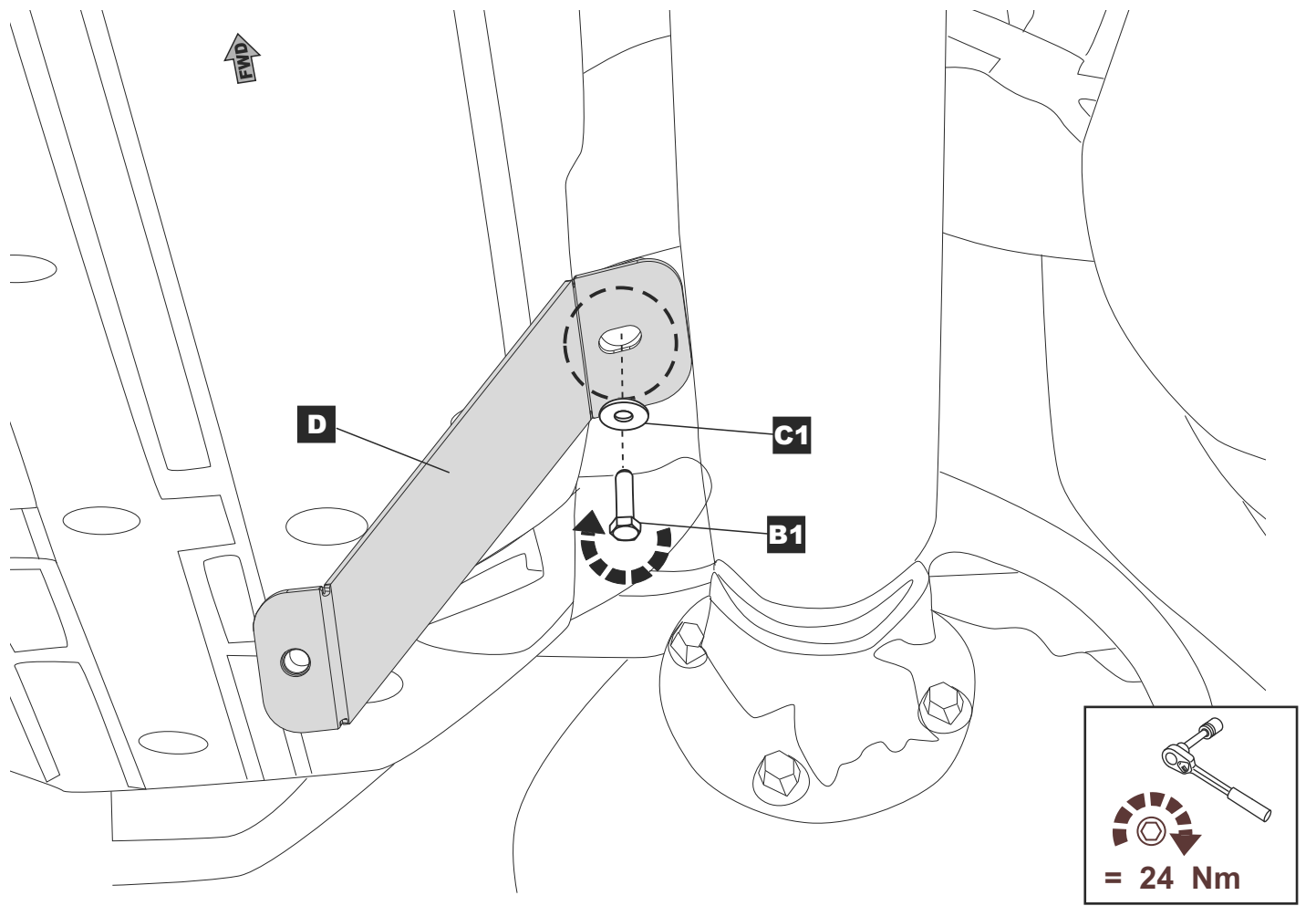

Part number:

PZ4AL-01597-00, PZ4AL-01588-00

Issue:

1

Date:

01/08/2012

Page:

4/6

5

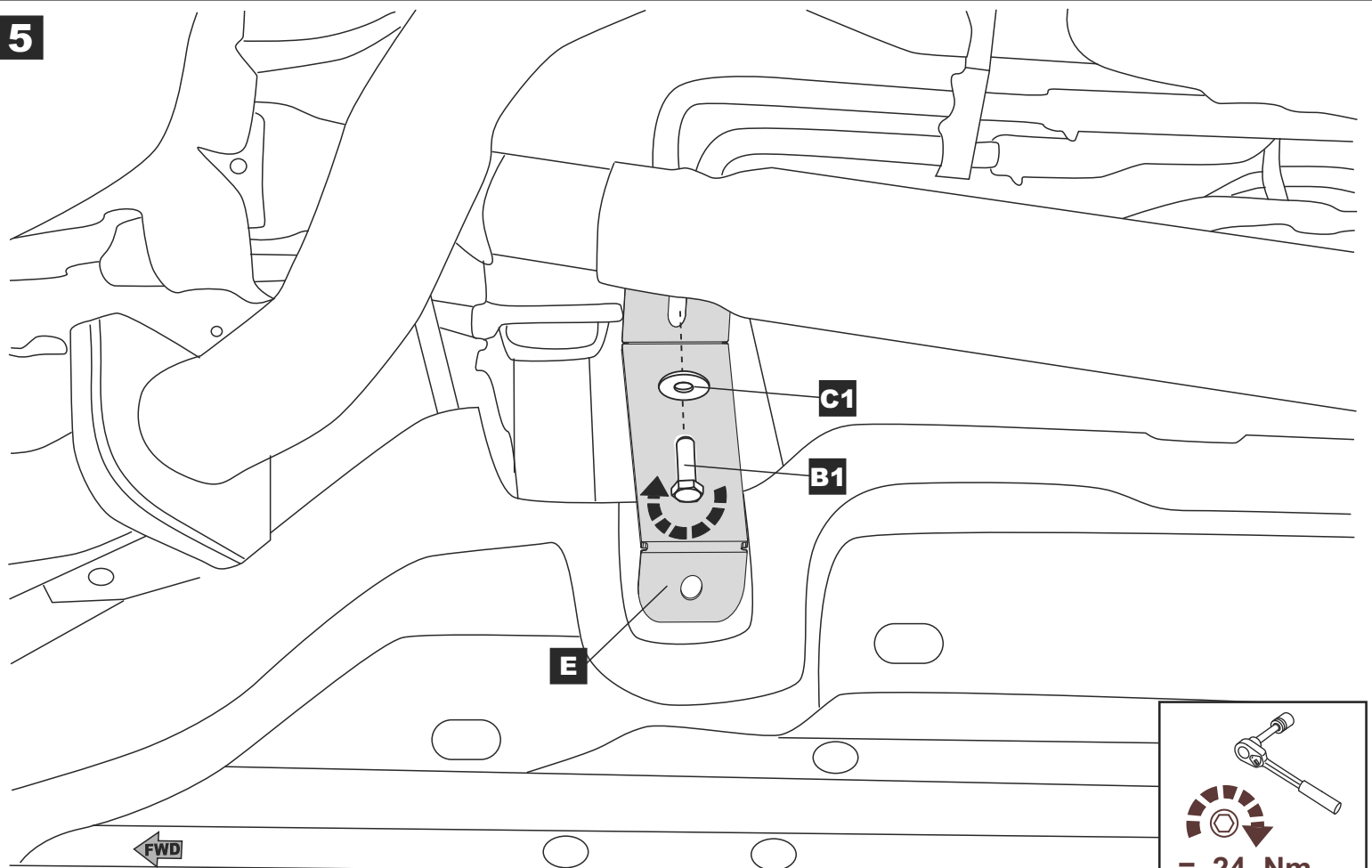

6

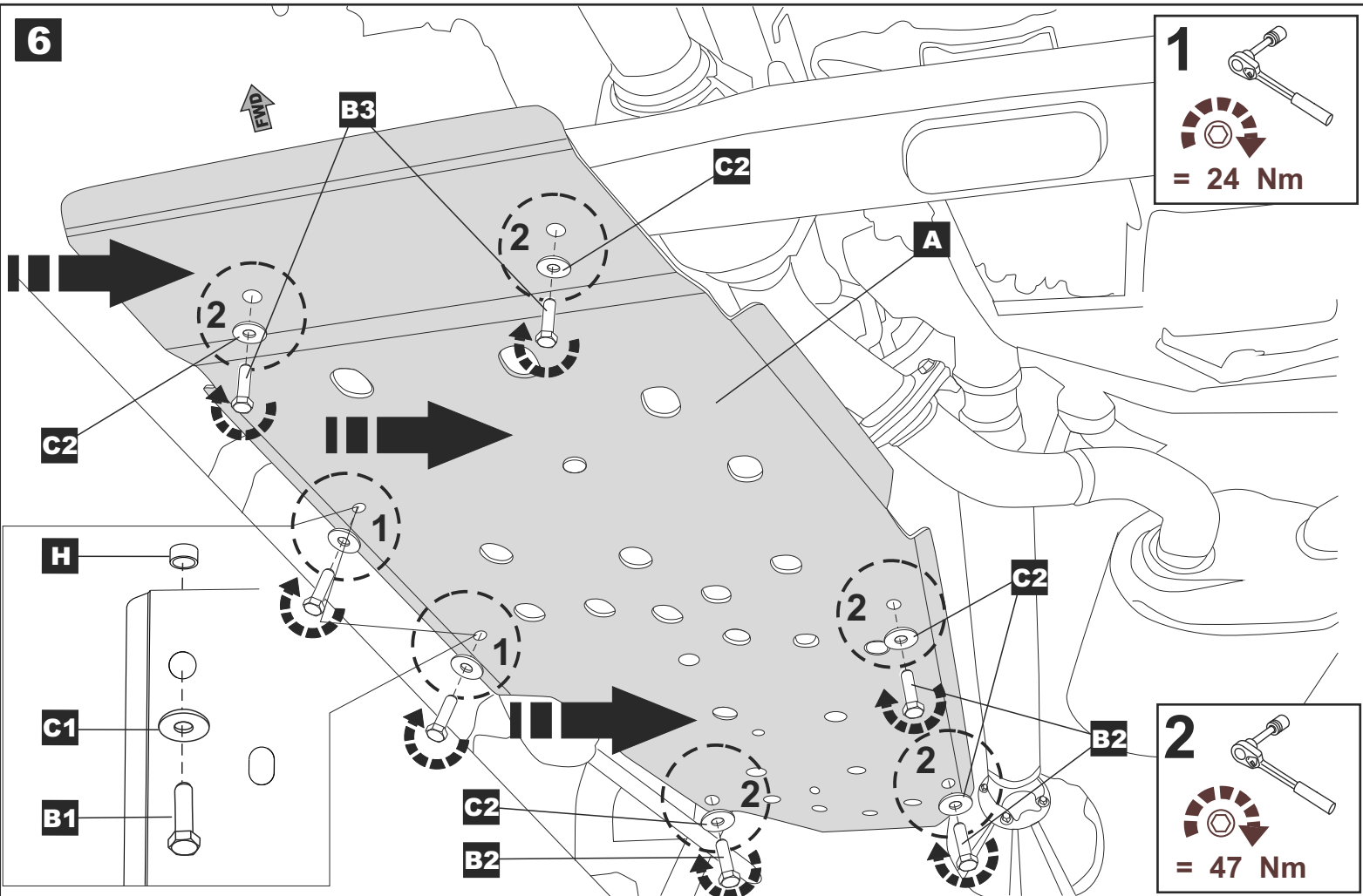

Part number:

PZ4AL-01597-00, PZ4AL-01588-00

Issue:

1

Date:

01/08/2012

Page:

5/6

7

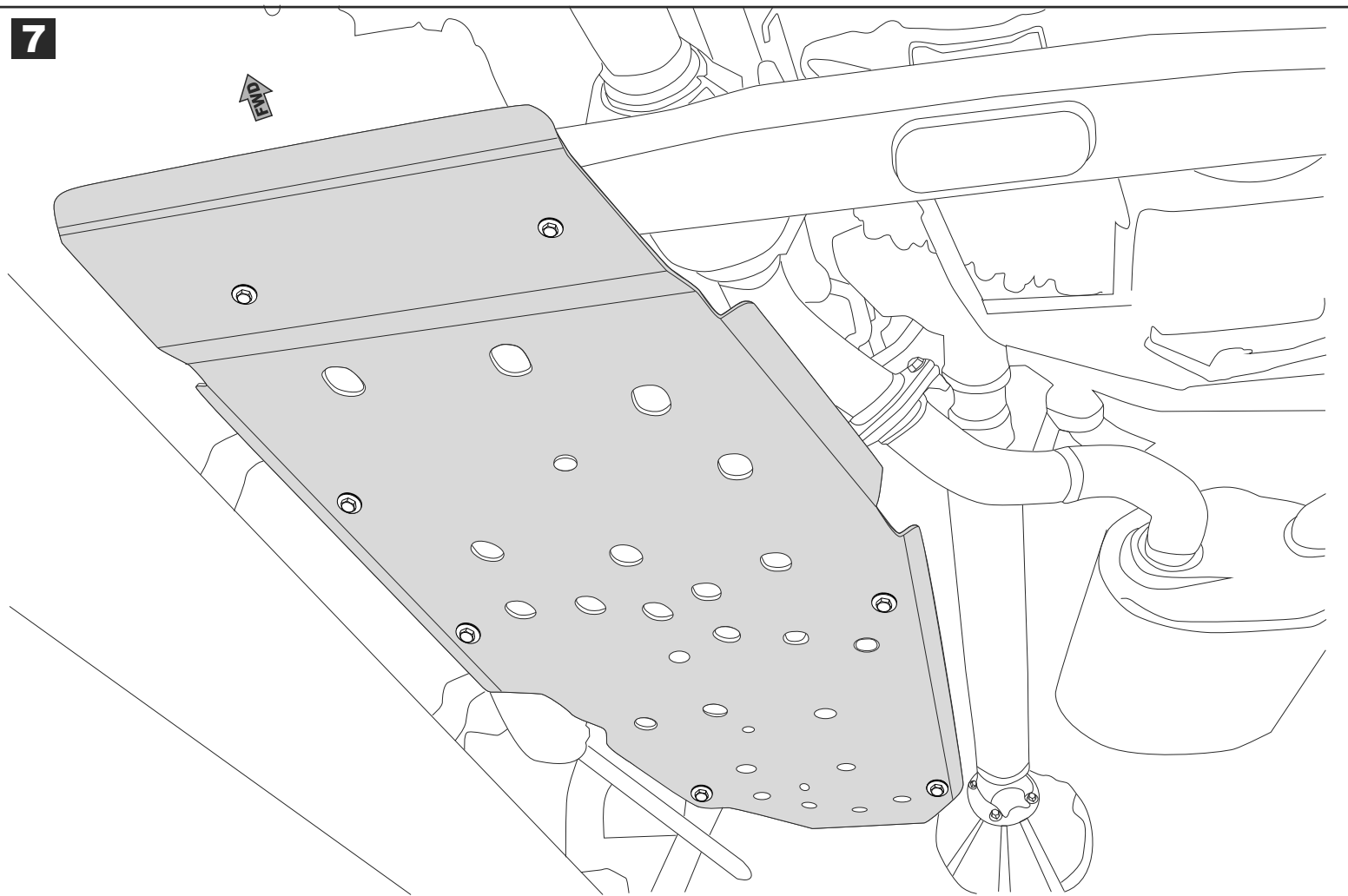

| | | | | |
|--|-------------|---------------------|--|--------------|
| Part number: PZ4AL-01597-00, PZ4AL-01588-00 | Issue: 1 | Date: 01/08/2012 | | Page: 6/6 |
|--|-------------|---------------------|--|--------------|